

**RoHS**  
COMPLIANT

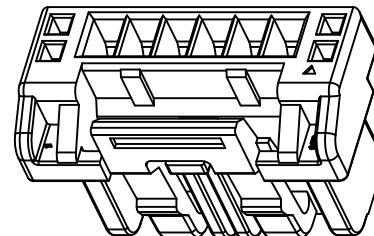
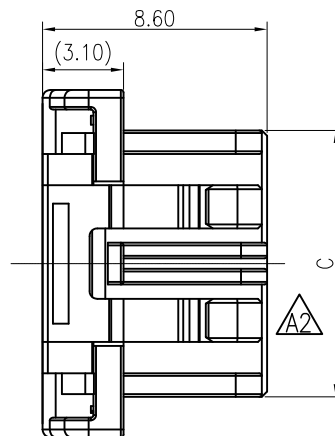
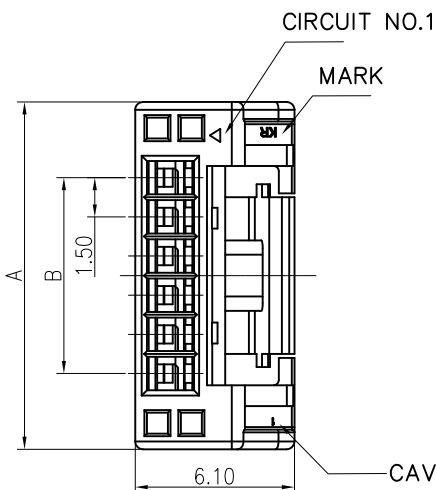
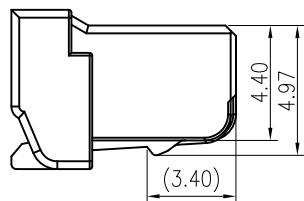

**SPECIFICATIONS**

1. Current rating: 3A (AWG #24)AC, DC
2. Voltage rating: 100V AC,DC
3. Temperature range: -40°C ~ +105°C
4. Insulation resistance:500MΩ Min.
5. Withstanding voltage: 500V AC/ minute.
6. Contact resistance: 20mΩ Max.

Material: PBT UL94 V-0  
Suitable: KR1507 series terminal  
Mate with KR1507 series wafer

Ordering Code:

H15070 \*\*\* 24 01A

No.of Circuits

102:02,  
115:15

Insulator Material  
24:PBT White

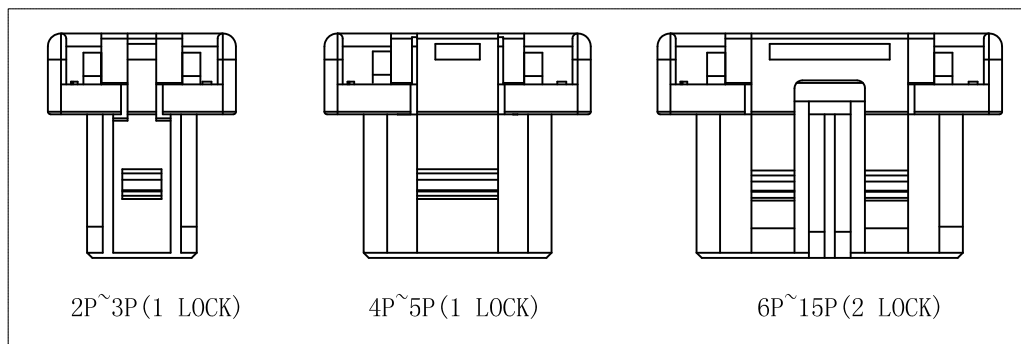

15P	26.80	21.00	23.70
14P	25.30	19.50	22.20
13P	23.80	18.00	20.70
12P	22.30	16.50	19.20
11P	20.80	15.00	17.70
10P	19.30	13.50	16.20
9P	17.80	12.00	14.70
8P	16.30	10.50	13.20
7P	14.80	9.00	11.70
6P	13.30	7.50	10.20
5P	11.80	6.00	8.70
4P	10.30	4.50	7.20
3P	8.80	3.00	5.70
2P	7.30	1.50	4.20
PIN数	A	B	C

LTR	REVISION DESCRIPTION	SIGNATURE	DATE	TOLERANCE	TITLE:	DRAWN:	CHECKED:	APPROVED:	VER.:	DRAWING NO.:
△3	Uniformly arrange the drawings	Shen	2021.09.17	X.X ±0.30	MX1.5 Inner buckle Housing	Shen 2021.09.17			A3	1507H101-A-S
△2	Delete Size	Arvin	2020.11.20	X.XX ±0.20					A3	
				X.XXX ±0.10					A3	
				Angle ±3°	UNIT:mm	SCALE:1/1	SHEET:1/1	PROJECTION		

**KONNRA** 东莞市康瑞电子有限公司  
DongGuan Konnra Electronics CO.,LTD

PART NO.:H150701\*\*2401A

VER.:A3 DRAWING NO.:1507H101-A-S

**RoHS**  
COMPLIANT

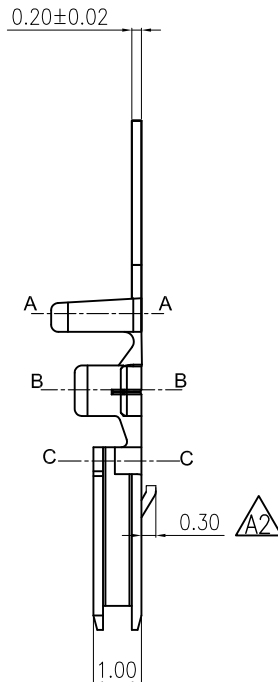
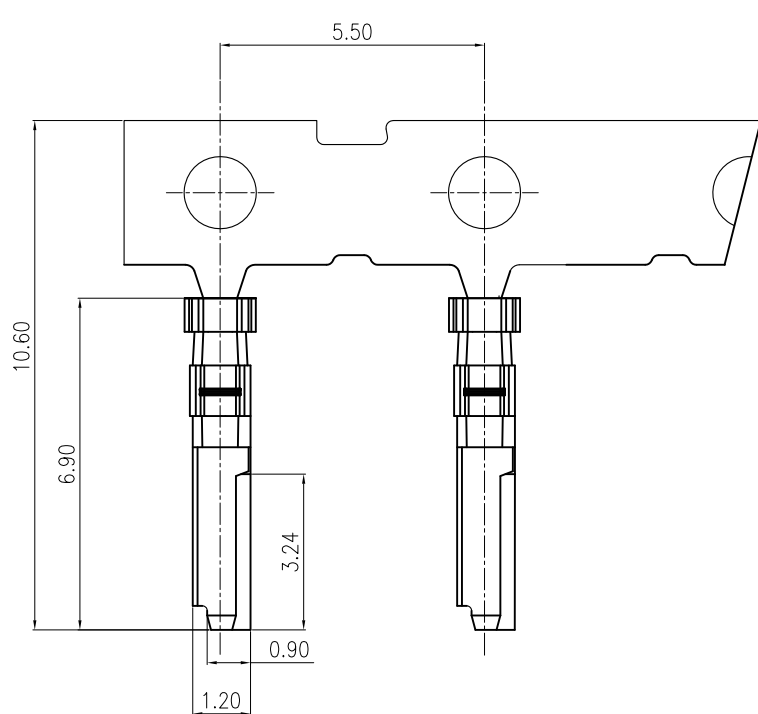

**SPECIFICATIONS**

1. Current rating: 3A (AWG #24)AC, DC
2. Voltage rating: 100V AC,DC
3. Temperature range: -40°C ~ +105°C
4. Insulation resistance: 500MΩ Min.
5. Withstanding voltage: 500V AC/ minute.
6. Contact resistance: 20mΩ Max.

Material: Phosphor Bronze  
 Finish: TIN plated over Nickel  
 Applicable wires: AWG #24~#28  
 Insulation O.D 0.78~1.28 mm  
 Qty/reel: 10,000 PCS

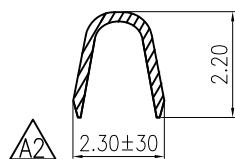

SECTION A-A

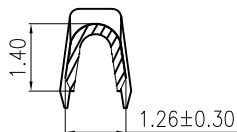

SECTION B-B

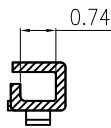

SECTION C-C

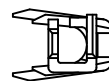

F		Uniformly arrange the drawings	Shen	2021.09.17	TOLERANCE X.X ±0.30 X.XX ±0.20 X.XXX ±0.10 Angle ±3°	TITLE: MX1.5 Inner buckle Terminal	DRAWN: Shen 2021.09.17		KONNRA 东莞市康瑞电子有限公司		
		Change the part number and frame format	Arvin	2020.11.20			CHECKED:		DongGuan Konnra Electronics CO.,LTD		
	LTR REVISION DESCRIPTION		SIGNATURE	DATE			APPROVED:		PART NO.: T15070PT0101A		
	1	2	3	4	UNIT:mm	SCALE: 1/1	SHEET: 1/1	PROJECTION	VER.: A3	DRAWING NO.: 1507T101-A-S	
	1	2	3	4	5	6	7	8	9		

**RoHS**  
COMPLIANT

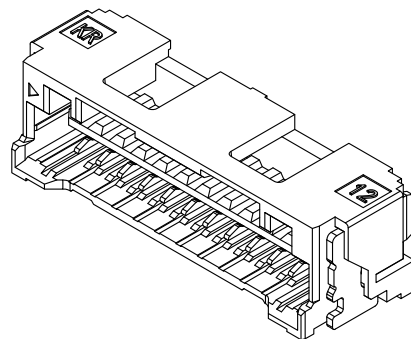
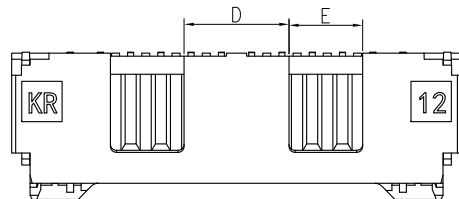

**SPECIFICATIONS**

1. Current rating: 3A (AWG #24)AC, DC
2. Voltage rating: 100V AC,DC
3. Temperature range: -40°C ~ +105°C
4. Insulation resistance:500MΩ Min.
5. Withstanding voltage: 500V AC/ minute.
6. Contact resistance: 20mΩ Max.

**Material:**

Insulator: PA9T UL 94V-0

Pin: Phosphor bronze

**A3** Fitting Nail: Brass

Plating: Tin plated over Nickel

Mate with KR1507 series Housing

**PART NO:**

C1507VS1\*\*11M0101RA

02: 2P

16: 16P

11: PA9T Natural

M01: Matte Tin

R: Reel  
P: Bag

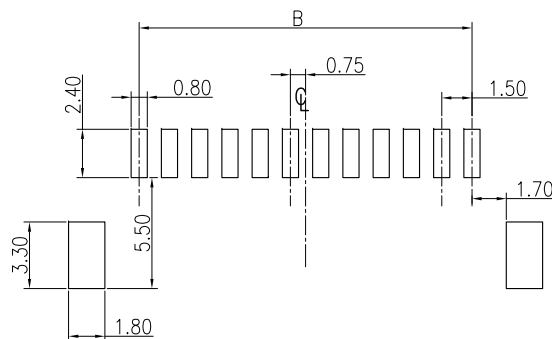
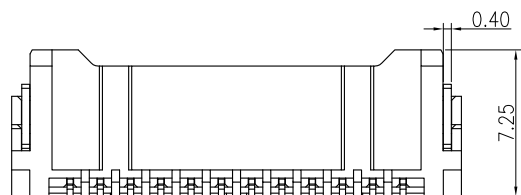
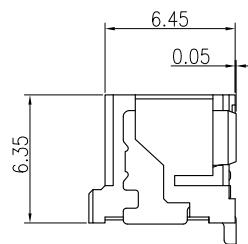
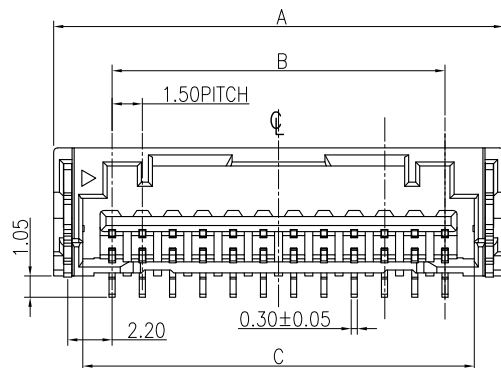

Recommended P.C.B. Layout  
Total tolerance:±0.05mm

15P	26.80	21.00	23.90	5.20	3.65
14P	25.30	19.50	22.40	5.20	
13P	23.80	18.00	20.90	5.20	
12P	22.30	16.50	19.40	5.20	
11P	20.80	15.00	17.90	5.20	
10P	19.30	13.50	16.40	3.20	3.25
9P	17.80	12.00	14.90	3.20	
8P	16.30	10.50	13.40	2.50	3.25
7P	14.80	9.00	11.90	2.50	2.50
6P	13.30	7.50	10.40	2.30	2.15
5P	11.80	6.00	8.90	—	3.60
4P	10.30	4.50	7.40	—	3.30
3P	8.80	3.00	5.90	—	2.55
2P	7.30	1.50	4.40	—	1.85
PIN	A	B	C	D	E

F	<b>MARK</b>	<b>REVISION DESCRIPTION</b>	<b>SIGNATURE</b>	<b>DATE</b>	<b>TOLERANCE</b>	<b>TITLE:</b>	<b>DRAWN:</b> Shen 2021.09.08	<b>KONNRA</b> 东莞市康瑞电子有限公司 DongGuan Konnra Electronics Co.,Ltd.		
	<b>A4</b>	Uniformly arrange the drawings	Shen	2021.09.08	X.X ±0.30	MX1.5 SMT 180° INNER BUCKLE WF	<b>CHECKED:</b>			
	<b>A3</b>	Change the table	Arvin	2020.11.20	X.XX ±0.20		<b>APPROVED:</b>	<b>PART NO.:</b> C1507VS1**11M0101RA		
					X.XXX ±0.10	<b>UNIT:</b> mm	<b>SCALE:</b> 1/1	<b>SHEET:</b> 1/2	<b>PROJECTION:</b>	<b>REV.:</b> A4
				Angle ±2°						

RoHS  
COMPLIANT

2P VIEW

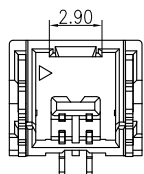

3P VIEW

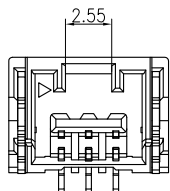

4P VIEW

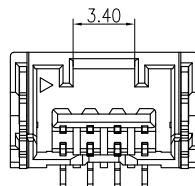

5P VIEW

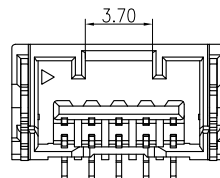

6P VIEW

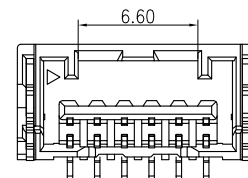

7P VIEW

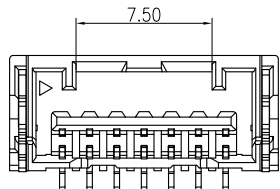

8P VIEW

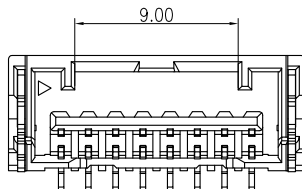

9P VIEW

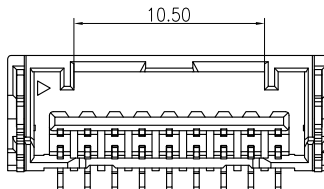

10P VIEW

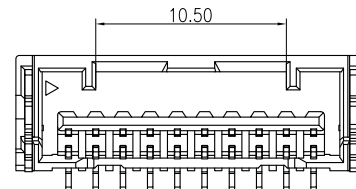

11P VIEW

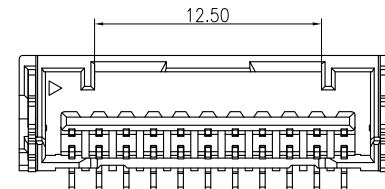

13P VIEW

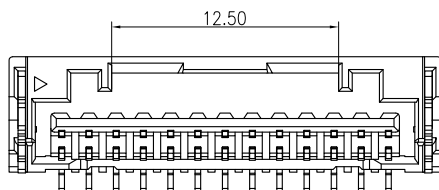

14P VIEW

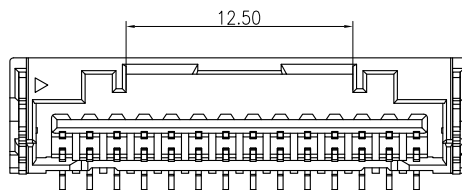

15P VIEW

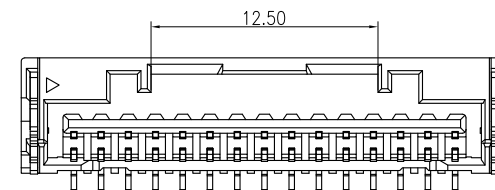

A3

Uniformly arrange the drawings

Shen

2021.09.08

TOLERANCE

X.X ±0.30

X.XX ±0.20

X.XXX ±0.10

Angle ±2°

TITLE:

MX1.5 SMT 180°  
INNER BUCKLE WF

DRAWN: Shen 2021.09.08

CHECKED:

APPROVED:

KONNRA 东莞市康瑞电子有限公司

DongGuan Konnra Electronics Co.,Ltd.

PART NO.: C1507VS1\*\*11M0101RA

MARK

REVISION DESCRIPTION

SIGNATURE

DATE

UNIT:mm

SCALE:1/1

SHEET:2/2

PROJECTION

REV.:A4

DRAWING NO.:1507WVS101-A-S

1

2

3

4

5

6

7

8

9

**RoHS**  
COMPLIANT

**SPECIFICATIONS**

1. Current rating: 3A (AWG #24)AC, DC
2. Voltage rating: 100V AC,DC
3. Temperature range: -40°C ~ +105°C
4. Insulation resistance:500MΩ Min.
5. Withstanding voltage: 500V AC/ minute.
6. Contact resistance: 20mΩ Max..

**Material:**

Insulator: PA9T UL 94V-0  
Pin: Phosphor bronze  
Fitting Nail: Brass  
Plating: Tin plated over Nickel  
Mate with KR1507 series Housing

PART NO: C1507RS1\*\*11M0101RA

02: 2P  
16: 16P  
11:PA9T Natural  
M01: Matte Tin  
R: Reel  
P: Bag

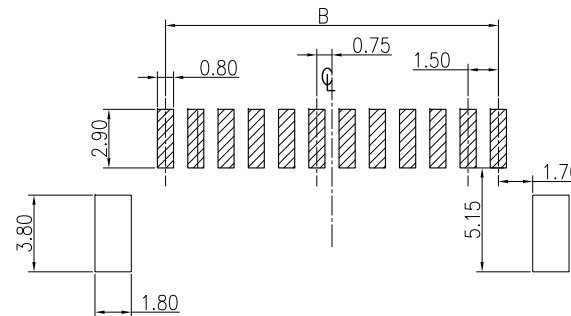
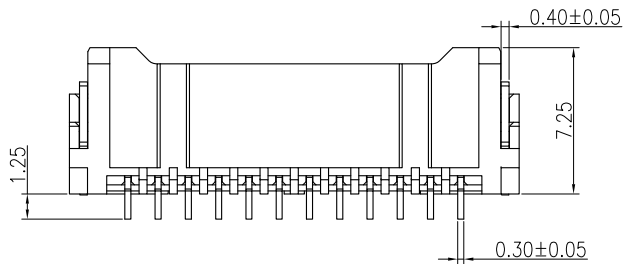
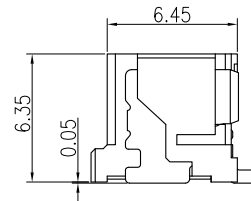
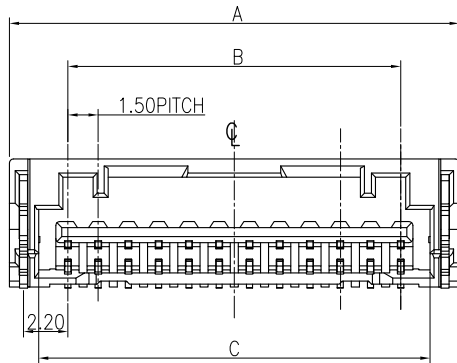
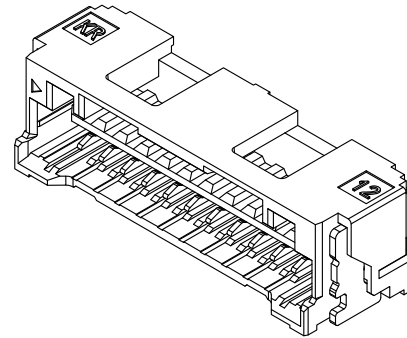
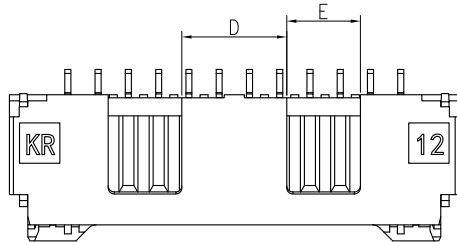

Recommended P.C.B. Layout

Total tolerance:±0.05mm

15P	26.80	21.00	23.90	5.20	3.65	
14P	25.30	19.50	22.40	5.20		
13P	23.80	18.00	20.90	5.20		
12P	22.30	16.50	19.40	5.20		
11P	20.80	15.00	17.90	5.20		
10P	19.30	13.50	16.40	3.20		
9P	17.80	12.00	14.90	3.20		
8P	16.30	10.50	13.40	2.50		3.25
7P	14.80	9.00	11.90	2.50		2.50
6P	13.30	7.50	10.40	2.30		2.15
5P	11.80	6.00	8.90	—	3.60	
4P	10.30	4.50	7.40	—	3.30	
3P	8.80	3.00	5.90	—	2.55	
2P	7.30	1.50	4.40	—	1.85	
PIN	A	B	C	D	E	

F		Uniformly arrange the drawings	Shen	2021.09.08	TOLERANCE X.X ±0.30 X.XX ±0.20 X.XXX ±0.10 Angle ±2°	TITLE: MX1.5 SMT 90° INNER BUCKLE WF	DRAWN: Shen 2021.09.28		KONNRA 东莞市康瑞电子有限公司	
		Change the table	Arvin	2020.11.20			CHECKED:		DongGuan Konnra Electronics Co.,Ltd.	
	MARK	REVISION DESCRIPTION	SIGNATURE	DATE			UNIT:mm	SCALE:1/1	SHEET:1/2	PROJECTION

**RoHS**  
COMPLIANT

2P VIEW

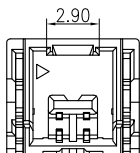

3P VIEW

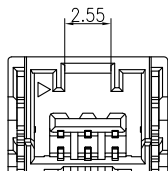

4P VIEW

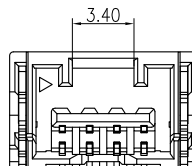

5P VIEW

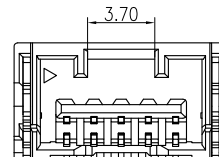

6P VIEW

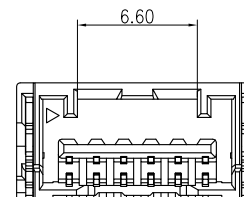

7P VIEW

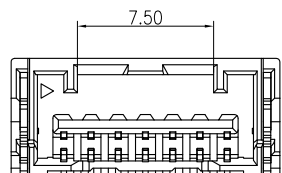

8P VIEW

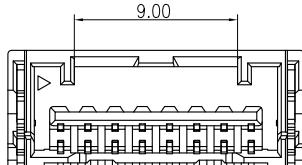

9P VIEW

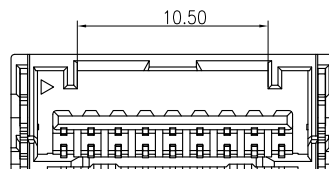

10P VIEW

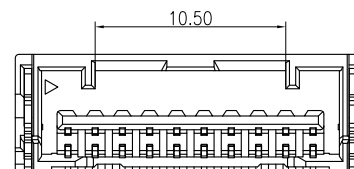

11P VIEW

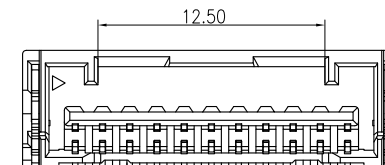

13P VIEW

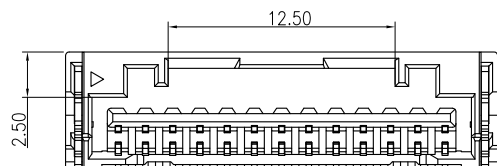

14P VIEW

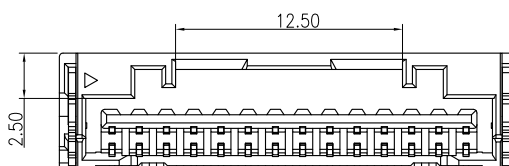

15P VIEW

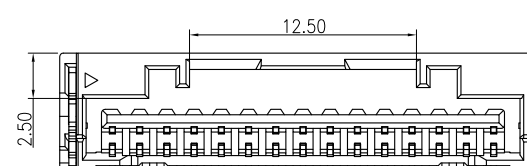

Uniformly arrange the drawings

Shen

2021.09.08

TOLERANCE

X.X ±0.30

X.XX ±0.20

X.XXX ±0.10

Angle ±2°

TITLE:

MX1.5 SMT 90°  
INNER BUCKLE WF

DRAWN: Shen 2021.09.28

CHECKED:

APPROVED:

**KONNRA** 东莞市康瑞电子有限公司

DongGuan Konnra Electronics Co.,Ltd.

PART NO.: C1507RS1\*\*11M0101RA

MARK

REVISION DESCRIPTION

SIGNATURE

DATE

UNIT:mm

SCALE:1/1

SHEET:2/2

PROJECTION

REV.:A4

DRAWING NO.:1507WHS101-A-S

1

2

3

4

5

6

7

8

9